

HIGH PRESSURE RELIEF VALVES

H-900HP SERIES

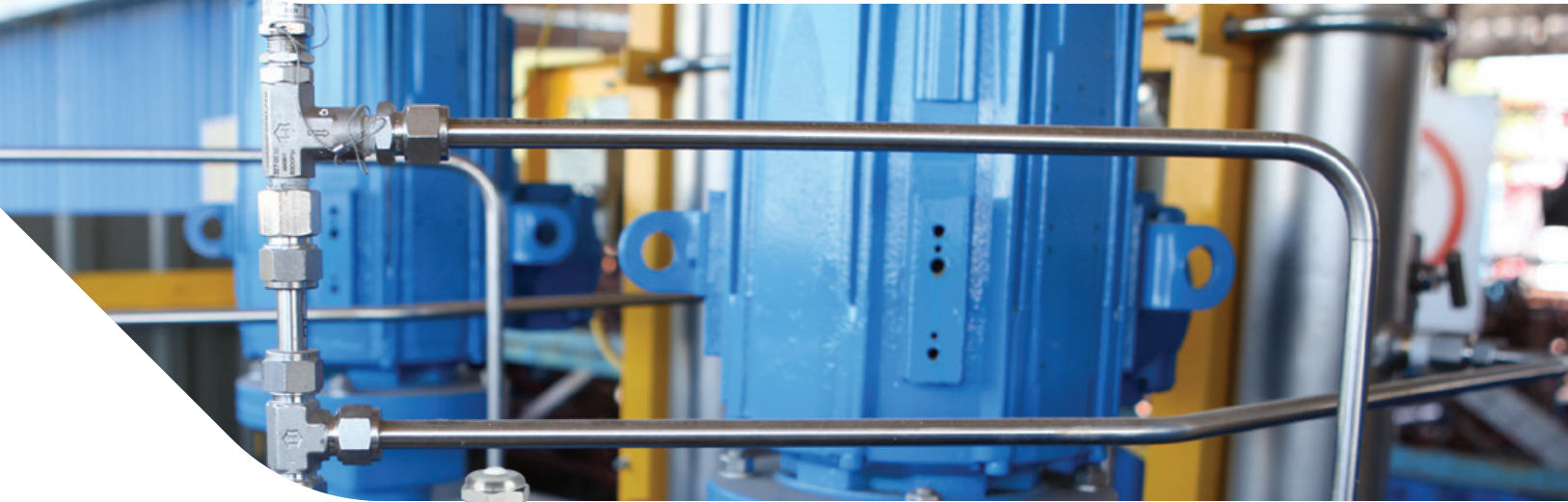

FEATURES

- St.St. 316 construction
- MAWT up to 6000 psi
- Set Pressure from 50 psig to 6000 psig (3.50 to 414 bar)
- Identifying colored springs for each pressure range
- Replaceable springs for variable pressure ranges
- Available in all pipe threads and LET-LOK® connections
- Option to comply with standards GE/PED
- Sizes range: 1/4", 1/2", 6mm and 12mm

GENERAL

The H-900 HP Series is a relief valve designed for high-pressure services. It is most suited for use where changes in pressure can cause process issues, system damage or personal injury.

MATERIALS OF CONSTRUCTION

Item No.	Components	Qty.	1/4" Body Size	1/2" Body Size
1	Cap Plug	1	Polypropylene	Polypropylene
2	Label	1	Polyester	Polyester
3	Adjustment Cap	1	St.St 316	St.St 316
4	Spring	1	St.St. 302,17-7PH	St.St. 302,17-7PH
5	Lower Spring Button	1	St.St 316	-
5A	Lower Spring Button	1	-	St.St 316
6	Locking Nut	1	St.St 316	St.St 316
7	Bonnet	1	St.St 316	St.St 316
8	O-Ring	1	Fluorocarbon FKM	Fluorocarbon FKM
9	Quad Ring	1	Fluorocarbon FKM	Fluorocarbon FKM
10	Retaining Ring	1	PH15-7 Mo	-
10A	Location Ring	1	-	St.St 316
11	*Stem	1	St.St 316	-
11A	*Stem	1	-	St.St. 316 bonded with Fluorocarbon FKM
12	*Clamps Screw	1	St.St 316	-
13	*O-Ring	1	Fluorocarbon FKM	-
14	*Insert	1	St.St 316	-
15	*Body	1	St.St 316	St.St 316
	*Lubricant		Silicone based and PTFE based	

* Wetted parts

PRESSURE TEMPERATURE RATING

Series	H-900HP Body Size: 1/4" & 1/2"			
	Fluorocarbon FKM	Buna N	Polychloroprene (CR)	EPDM
TEMP °C (°F)	MAX SET PRESSURE psig (bar)			
-40 (-40)	-	-	-	-
-34 (-30)				
-23 (-10)				
-18 (0)				
-12 (10)				
-4 (25)	6000 (413)	6000 (413)	6000 (413)	-
-1 (30)				
10 (50)				
65 (150)	5600 (386)	5600 (386)	5600 (386)	5600 (386)
93 (200)	5200 (358)	5200 (358)	5200 (358)	5200 (358)
121 (250)	4900 (338)	4900 (338)	4900 (338)	4900 (338)
135 (275)	-	-	4700 (324)	-
148 (300)				

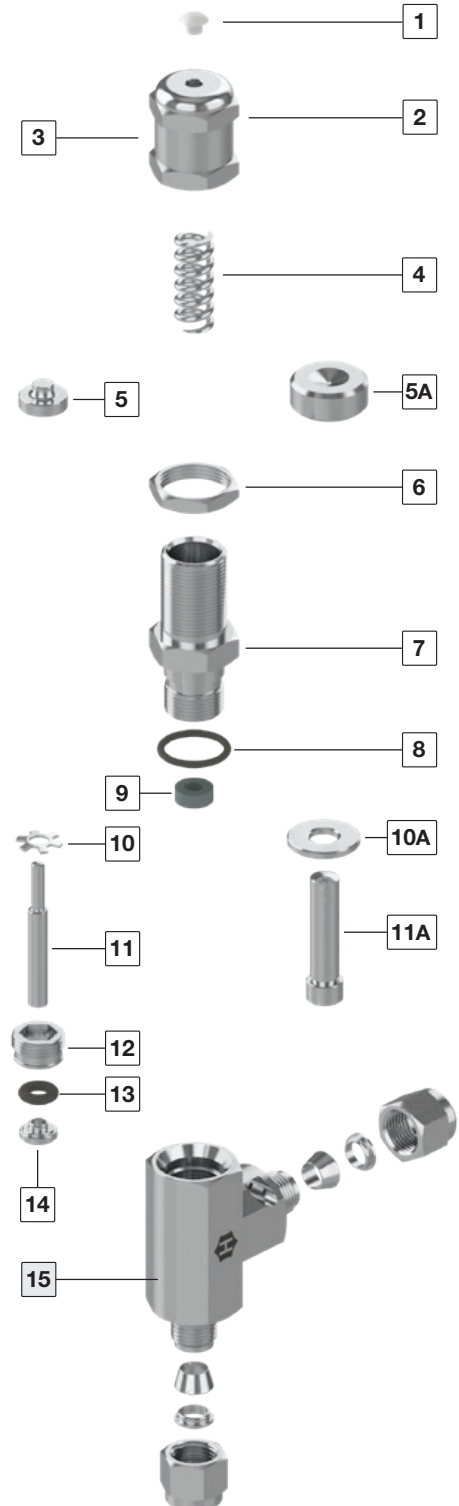

CLEANING & PACKAGING

Every H-900HP series relief valve is cleaned in accordance with Standard Cleaning and Packaging Procedure 8184. Oxygen Clean & Lubricant-Free Cleaning and packaging is conducted in accordance with Special Cleaning and Packaging Procedure 8185.

TESTING

The H-900HP Relief Valve designs have been tested for proof and burst. Every H-900HP Relief Valve is factory tested for proper assembly, set and resealing performance. No detectable leakage is allowed during the shell test.

NOMINAL CRACKING PRESSURE RANGE FOR 1/4"

psig	Bar	Spring Designator	Color
50-350	3.4 - 24	A	White
350-750	24 - 51.5	B	Blue
750-1500	51.5 - 103	C	Gold
1500-2250	103 - 155	D	Turquoise
2250-3000	155 - 206	E	Green
3000-4000	206 - 275	F	Red
4000-5000	275 - 344	G	Silver
5000-6000	344 - 413	H	Black

NOMINAL CRACKING PRESSURE RANGE FOR 1/2"

psig	Bar	Spring Designator	Color
50-350	3.4 - 24	A	White
350-750	24 - 51.5	B	Blue
750-1500	51.5 - 103	C	Gold

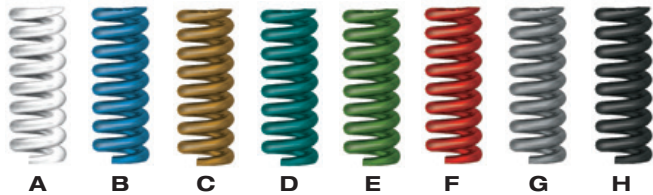

STANDARD CONFIGURATION DIMENSIONS

Description	Connection / size		Orifice*		Dimensions							
	Inlet	Outlet			A		B		C		D	
			mm	inch	mm	inch	mm	inch	mm	inch	mm	inch
H-900HP	1/4 LET-LOK	1/4 LET-LOK	3.6	0.14	37	1.45	39	1.53	50	1.97	96.0	3.78
H-900HP	6MM LET-LOK	6MM LET-LOK			37	1.45	39	1.53	50	1.97	96.0	3.78
H-985HP	1/4 Male NPT	1/4 Female NPT			32	1.26	30	1.18	40	1.57	88.6	3.49
H-995HP	1/4 Male NPT	1/4 LET-LOK			32	1.26	39	1.53	50	1.97	88.6	3.49
H-900HP	1/2 LET-LOK	1/2 LET-LOK	6.4	0.25	46.5	1.83	46.5	1.83	59.2	2.33	150	5.92
H-900HP	12MM LET-LOK	12MM LET-LOK			46.5	1.83	46.5	1.83	59.2	2.33	150	5.92
H-985HP	1/2 Male NPT	1/2 Female NPT			36.3	1.43	36.3	1.43	49	1.93	140	5.52
H-995HP	1/2 Male NPT	1/2 LET-LOK			36.3	1.43	46.5	1.83	59.2	2.33	140	5.52

* Orifice in fully open position

SETTING AND RE-SEALING PRESSURE

- Upstream set pressure is the first indicator of flow process. Every pressure relief after the first is repeatable within a deviation of 5% at room temperature.
- Blocked upstream set pressure is the first indicator of a stopped flow process and is always lower than the set pressure.
- Lubricant-Free cleaned valves have higher reseal pressure.

H-900HP RE-SEAL PRESSURE

Series	Test Set Pressure psig (bar)	Min Resealing Pressure as a Percentage of set pressure, %
H-900HP	100 - 200 (6.8 to 13.7)	50
	850 - 1000 (58.5 to 68.9)	84

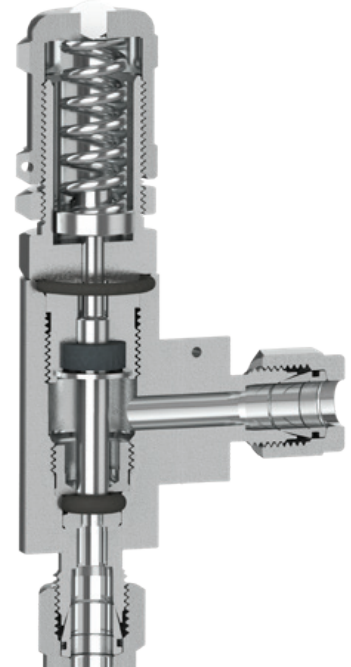
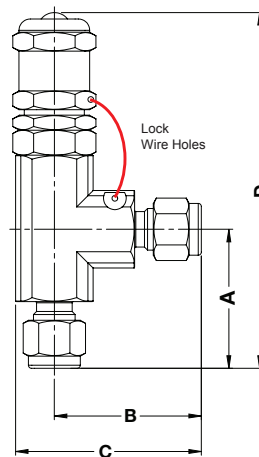

FLOW DATA AT 70°F (20°C) FOR 1/4" BODY SIZE



A
SPRING 50-350psig



B
SPRING 350-750psig

AIR FLOW

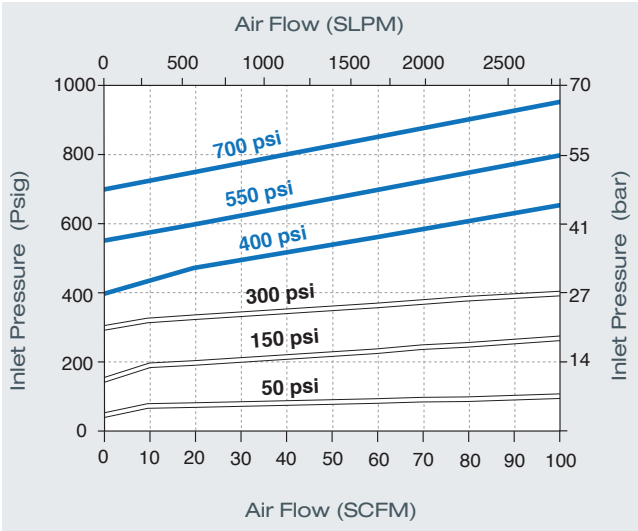

WATER FLOW

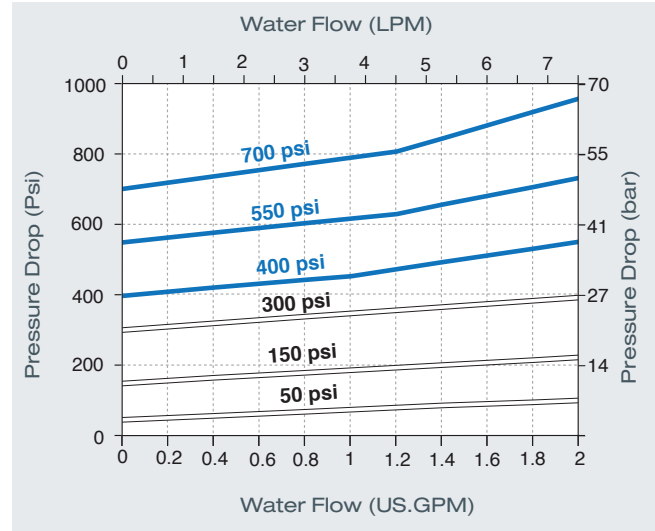

C
SPRING 750-1500psig



D
SPRING 1500-2250psig

AIR FLOW

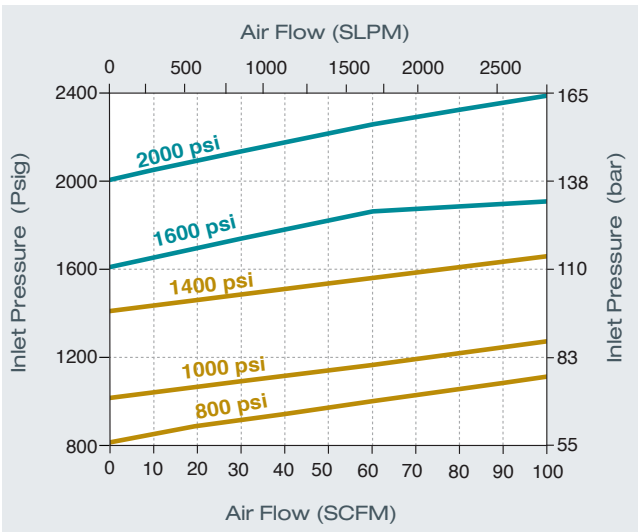

WATER FLOW

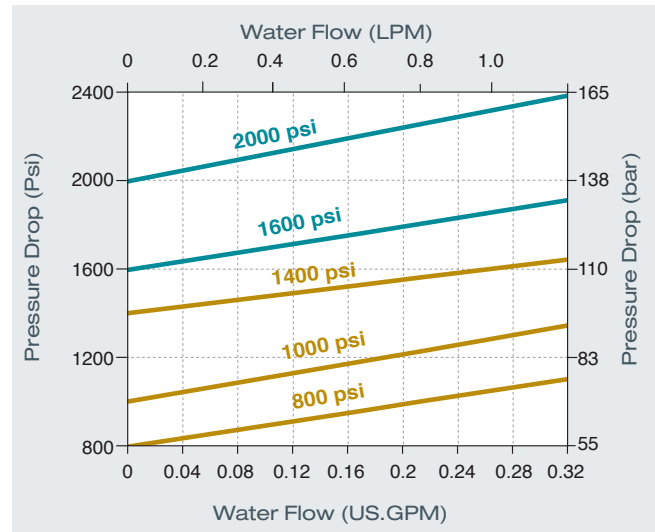

FLOW DATA AT 70°F (20°C) FOR 1/4" BODY SIZE



E

SPRING 2250-3000psig



F

SPRING 3000-4000psig

AIR FLOW

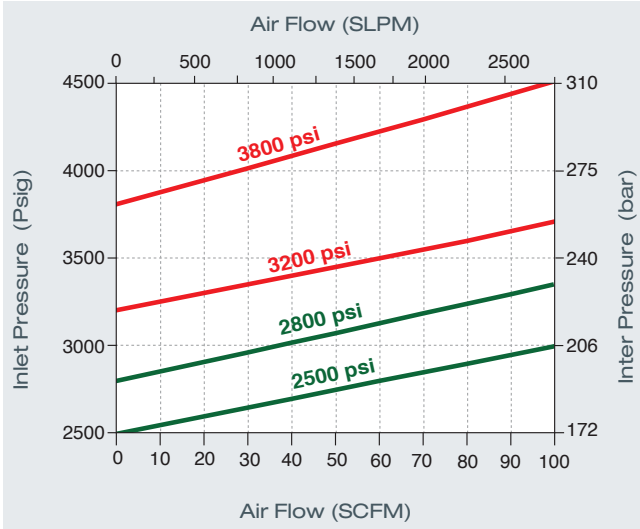

WATER FLOW

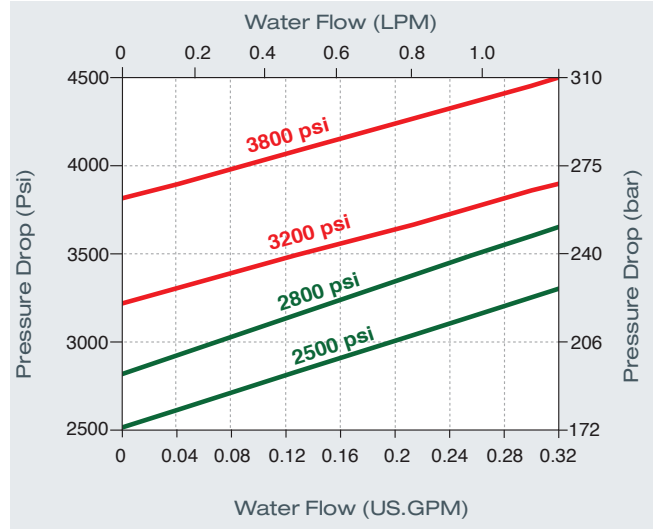

G

SPRING 4000-5000psig



H

SPRING 5000-6000psig

AIR FLOW

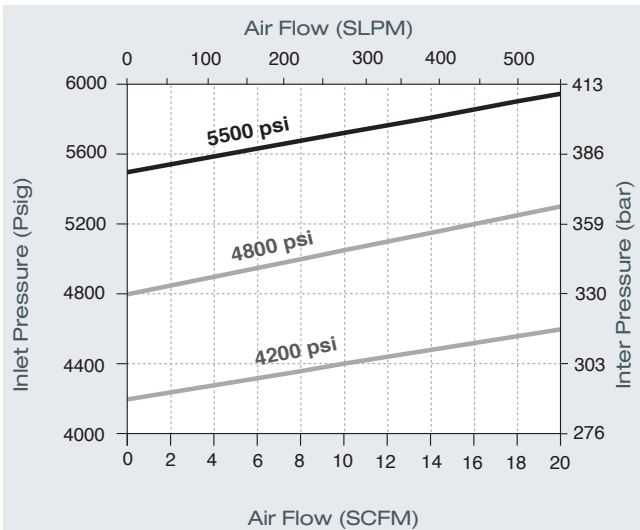

WATER FLOW

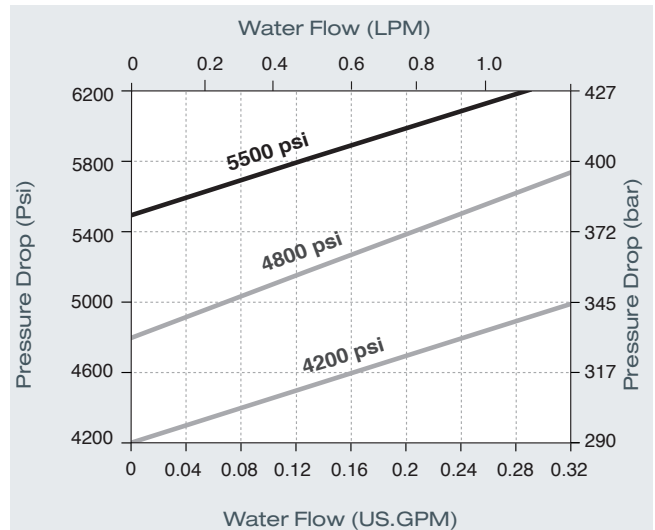

FLOW DATA AT 70°F (20°C) FOR 1/2" BODY SIZE



A
SPRING 50-350psig



B
SPRING 350-750psig

AIR FLOW

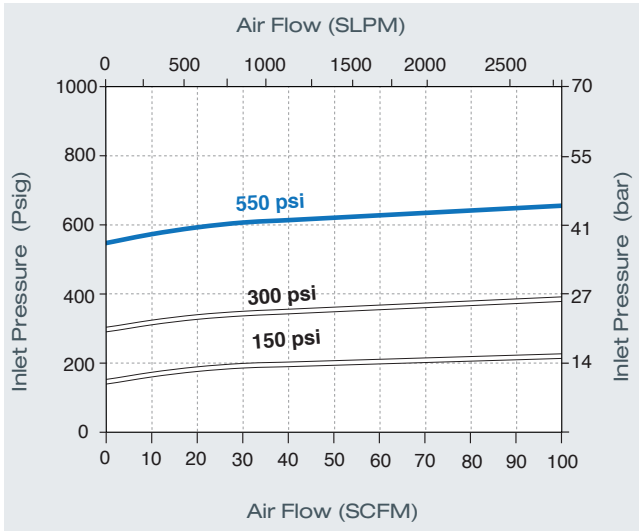

WATER FLOW

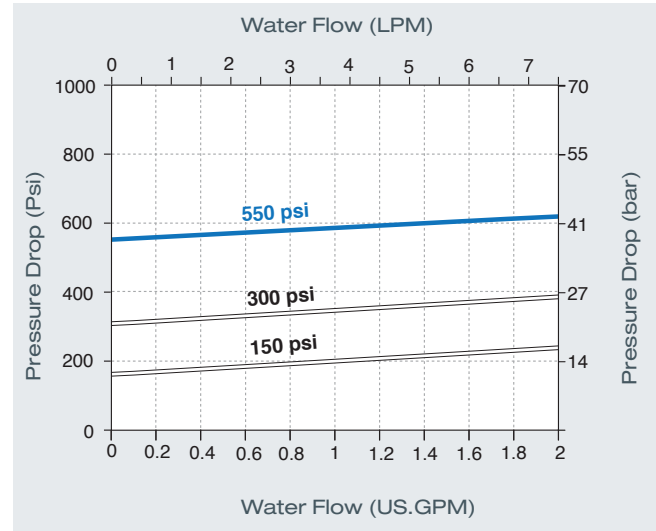

C
SPRING 750-1500psig

AIR FLOW

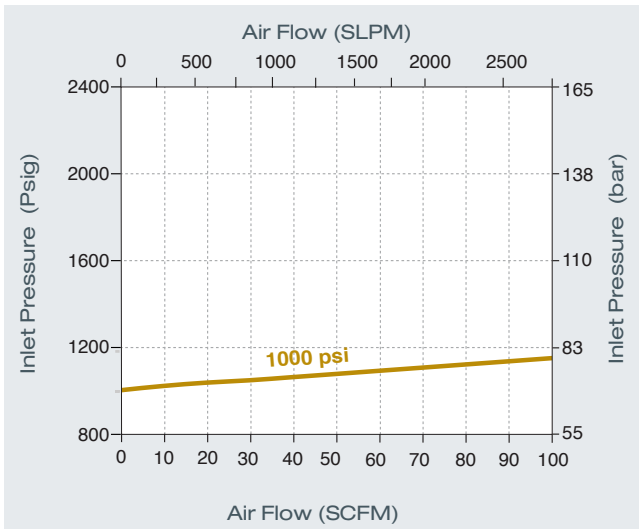

WATER FLOW

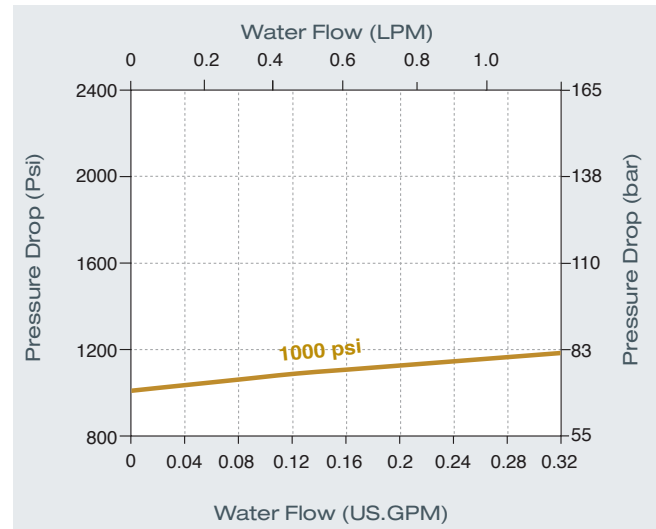

APPLICATIONS

The H-900HP is a relief valve and therefore is not certified to ASME due to not having capacity rating at a given pressure rise (accumulation).

OPERATION

H-900HP relief valves open when system pressure gets to the set pressure and close when system pressure drops below the set pressure.

Warning

- Valves that have not been actuated for some time may contain pressure higher than the set pressure.
- The system designer and user have the sole responsibility for selecting products that will conform to the specific safety codes appropriate for the system.

H-900HP ORDERING INFORMATION

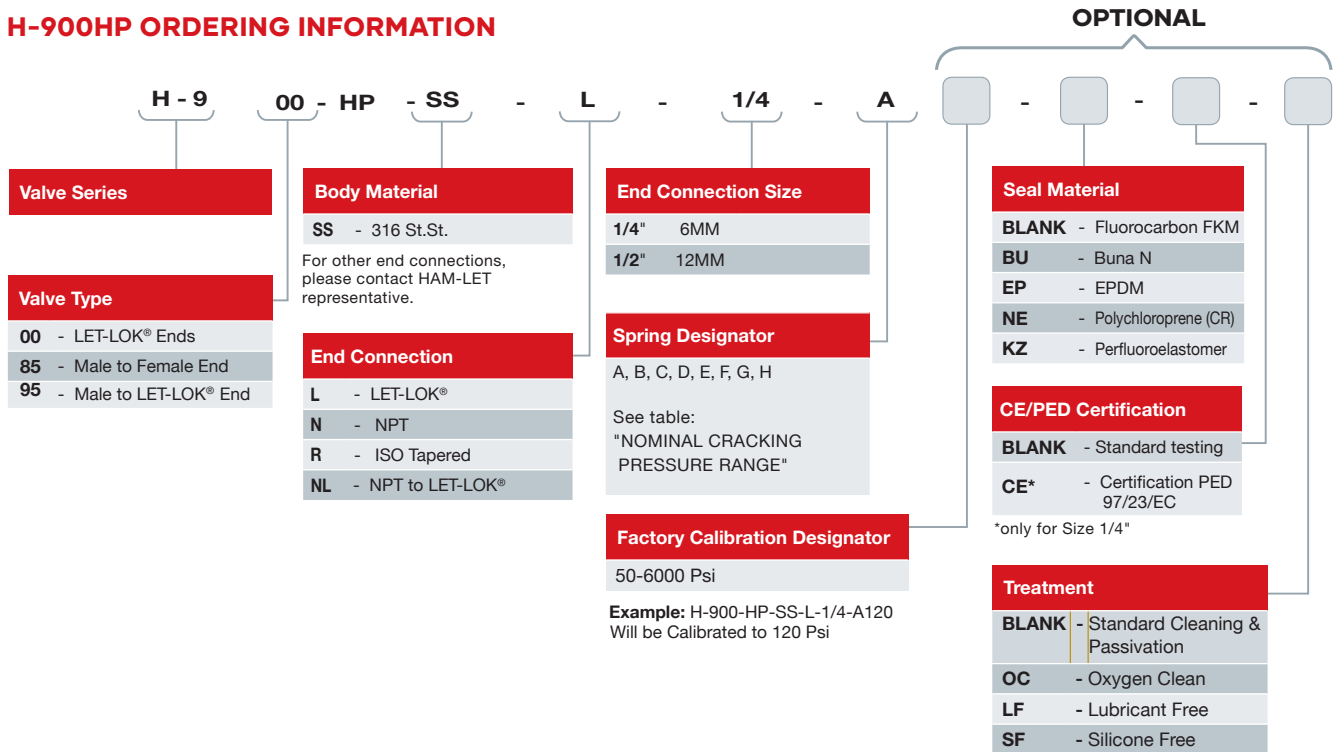

ORDERING INFORMATION FOR SPARE KITS

SPRING KIT

Includes:
Spring (specific to desired set pressure range) and label.

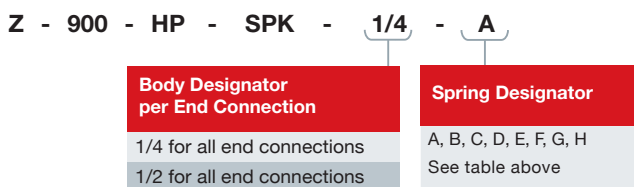

SEAL KIT

Includes: O-Rings and label

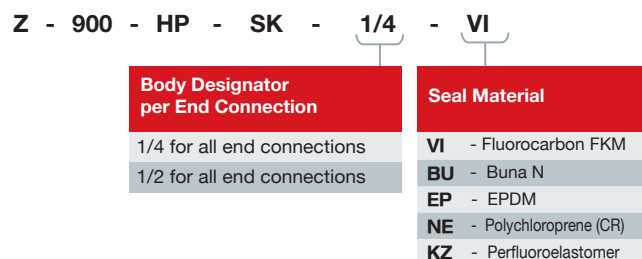

■ For oxygen applications work shall be carried out according to procedures for working with oxygen. In case spare kits are ordered for oxygen clean valves, such kits have to be ordered as oxygen clean by adding "-OC" designator.
Example: Z-900-HP-SK-1/4-VI-OC

Warning!

The system designer and user have the sole responsibility for selecting products suitable for their special application requirements, ensuring their safe and trouble-free installation, operation, and maintenance. Application details, material compatibility and product ratings should all be considered for each selected product. Improper selection, installation or use of products can cause property damage or personal injury.

H-900HP | 2020_Rev00

